

# ***FB25***



MANUAL OF USE AND MAINTENANCE

***FLOORWASH***<sup>®</sup>

Foreword	4
Manual content, use and maintenance	4
Storage of manual of use and maintenance	4
Updating the manual	4
Confidentiality	4
Machine delivery	4
FB25 Technical description	4
Liability limitations	5
Warranty	5
Serial number	6
General safety rules	6
Recommendations	6
Warnings	7
Li-Ion Battery	8
Li-Ion Battery Warnings	8
Li-Ion Battery Recommendations	9
Technical data	10
Battery technical data	10

Battery charger technical data	10
Spare parts	11
Packaging specifications and dimensions	12
Machine unpacking	12
Machine assembly	13
Installing the battery	14
Uninstalling the battery	14
Charging the battery	15
How to get started	16
ON/OFF	17
Battery charge level	18
Functioning	19
Transport	20
After cleaning	21
Maintenance	22
Troubleshooting tips	23

## **FOREWORD**

It is of outmost importance to keep the machine at its maximum efficiency by carrying out the maintenance described in this manual carefully. It is important to keep this instruction manual in a safe place so that it can be referred to whenever necessary. For further requirements, please contact our customer service centre or your nearest authorised dealer.

## **MANUAL CONTENT, USE AND MAINTENANCE**

The following manual has been drawn up to provide customers with all necessary information in order to use the machine as safely and smoothly as possible.

## **STORAGE OF MANUAL OF USE AND MAINTENANCE**

The manual of use and maintenance should be kept in a safe and easy accessible place in the immediate proximity to the machine. To avoid compromising its readability, keep this manual away from sources of heat, liquids or detergents.

## **UPDATING THE MANUAL**

The contents of this manual reflect the state of the art at the time the appliance was launched on the market.

The Manufacturer reserves the right to make changes to the machines at any time for any technical or commercial reasons whatsoever without any prior notice.

## **CONFIDENTIALITY**

The technical information (texts, drawings and illustrations) contained in this manual are the property of Floorwash® S.r.l. and must be considered confidential. It is strictly forbidden to disclose, reproduce or translate this document, even partially, without obtaining prior written permission from Floorwash® S.r.l.

## **MACHINE DELIVERY**

The Floorwash® S.r.l machine is delivered in a protective packaging. Ensure that the packaging is fully intact and that there are no signs of tempering when the product is taken over. The customer should notify our customer service immediately in case of damages.

## **FB25 TECHNICAL DESCRIPTION**

The FB25 is a mechanical floor scrubber-dryer that ensures effective cleaning surfaces including uneven superificies. The combined mechanical action of brush, water and centrifugal force will guarantee the best results with minimum effort. It cleans, rubs and collects the filth and it is perfect for constant and frequent use. This scrubber dryer is particularly suited for the treatment and cleaning of floors made of terracotta, pottery, setts, clinker, rubber, resin, marble, linoleum, raw concrete, flagstone, serizzo granite, stone, carpets and rugs.

## **LIABILITY LIMITATIONS**

Floorwash® S.r.l. declines any responsibility for damage to people and property caused by:

- Improper use of the machine or failure to comply with the instructions provided;
- Use of the machine not in compliance with the regulations in force;
- Use not in compliance with national safety and accident prevention laws;
- Tampering with even a single part of the machine;
- Incorrect installation and/or connection to the foreseen power sources or use of non-original spare parts.

## **WARRANTY**

Floorwash® S.r.l. warrants this product against manufacturing or material defects for a period of two years from the date of purchase. During this period, Floorwash® S.r.l. at its discretion, shall repair or replace any faulty product at no charge. However, Floorwash® S.r.l. specifies that the warranty is not valid in the following cases:

- Improper use of the machine;
- Lack of or improper maintenance;
- Use of non-original spare parts;
- Damage from natural events such as earthquakes, floods, fires or accidents;
- Tampering with or modifying the machine;

The warranty conditions neither minimise nor modify the legal provisions in force applicable to the sale of the product to the consumer.

The Warranty does not cover shipping costs which are borne by the customer.

## **SERIAL NUMBER**

The label with the serial number is located below the machine, in the underlying part of the external left side. That number shall be always notified for technical assistance or request of spare parts.

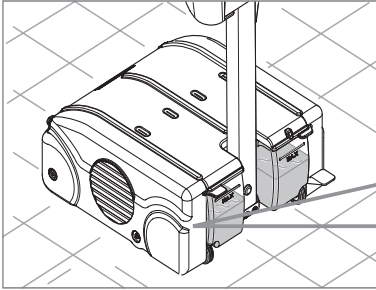

**FLOORWASH**<sup>®</sup>

11111111

## **GENERAL SAFETY RULES**

This floor scrubber-dryer is easy to use; anyway, it is necessary to read the following rules carefully in order to avoid damages to both the operator and the machine.

### **Recommendations**

- The machine is not intended to be used by persons (including children) whose physical, sensory and mental capacities are impaired, or with lack of the necessary experience and knowledge, unless they are supervised or instructed in its use by persons responsible for their safety.
- Children shall be supervised to ensure that they do not play with the machine.
- If the power supply is damaged, it shall be replaced by the manufacturer or its authorised technical assistance.
- Do not use the machine on slopes.
- Use only brushes provided with the machine or supplied by an authorised dealer and/or reseller to avoid compromising safety and warranty.
- The machine shall not be left unattended, but stored in a protected area to prevent the machine from being moved accidentally.

## **Warnings**



Do not use or keep the machine outside in wet conditions, and avoid direct exposure to rain.

---



The machine is suitable for use in dry conditions at a temperature range of +5°C to +35°C (+41°F to +95°F).

---



Do not insert objects through openings. Do not use when openings are clogged.

---



Protect the machine from sunlight and UV radiation.

---



Do not suck gases, liquids or potentially explosive and combustible dusts. These substances may corrode materials used in the construction of the machine.

---



Follow the basic safety rules for use in hazardous areas, such as service station or gas distributors.

---



Do not use the machine in potentially explosive atmospheres.

---



Do not place containers holding liquids on the machine.

---



For use in work environments, do not hit shelves or scaffoldings where there is a risk of objects falling. The user shall be equipped with adequate safety equipment (gloves, footwear, helmet, goggles, etc.).

---



Request original spare parts only to dealers and/or authorised resellers in case of parts replacement or maintenance.

---



Check the machine in an authorised service centre at least once a year.

---



Organise the disposal of waste materials complying scrupulously with current regulations.

---

## **LI-ION BATTERY**

### **Warnings**



Please read this manual carefully before using and checking the battery and charger.

---



The manufacturer declines any responsibility for damage to property and/or people resulting from the failure to comply with the warnings stated in the manual or the improper use of the battery.

---



Do not touch the electrodes with either your body or metal elements.

---



Before removing the battery, the device must be disconnected from the power supply.

---



Neither pour liquids on the battery nor immerse the battery in any kind of liquid whatsoever.

---



Do not burn or heat the battery as it may violently explode or burst into flames.

---



Do not leave the battery directly exposed to sunlight.

---



Keep the battery away from heat sources.

---



Do not break, open, force, weld or puncture the battery pack.

---



Do not solder cables to the battery poles; do not short-circuit the battery terminals.

---



Do not reverse the positive and negative terminals during use.

---



In case of battery leakage, avoid skin and eye contact.

---



In case of skin and eye contact with spilled liquids, seek immediate medical attention.

---



## **Recommendations**

- In the event of battery faults (odour emissions, excessive heat generation, deformation, etc.) or malfunctions, immediately remove the battery from the unit or charger and proceed with replacement and disposal.
- Only use chargers that are compatible with the technical specifications of the battery to be charged. The use of the Battery Charger supplied is for the exclusive purpose of charging the battery.
- Do not use or leave the battery exposed to high temperatures. The resulting overheating could compromise its functionality and durability.
- Do not use the battery in environments with static electricity or magnetic fields.
- Do not charge the battery below 0 degrees centigrade.
- Do not use the Floor Washer when the battery is low..
- The presence of dirt on the battery terminals could compromise the correct operation of the device. Clean the dirty terminals with a dry cloth before use.
- Stock and store the battery in a cool, dry place.
- Do not carry or store the battery with metal objects.
- Do not disperse the battery in the environment.
- The battery and charger present must be disposed of in accordance with local regulations. The Customer is legally responsible for the danger created when disposing of batteries.
- If the battery is stocked for a long period (more than three months) store it in a cool, dry place and perform a charge and discharge cycle every six months.

# **FLOORWASH**

## **TECHINCAL DATA FLOORWASH® FB25**

Machine weight	140 mm
Machine width	285 mm
Machine length	330 mm
Front brush	Ø 86 700 Rpm
Rear brush	Ø 54 1145 Rpm
Working width	250 mm
Working capacity	200 mq/h
Brushless motor power	580 Watt
Voltage	36 V DC
Total storage capacity	4 l
Recovery tank capacity	1 l
Total empty weight (without battery)	8,5 kg

## **BATTERY TECHNICAL DATA**

Supplied voltage	36 Volt
Supplied urrent	5,8 A/h - 208,8 Watt/h
Dimensions	110 mm X 170 mm X 102 mm
Max autonomy	60 min
Recharge time	90 min
Weight	1,40 kg

## **CHARGER TECHNICAL DATA**

Input Voltage	100 - 240 V
Output Current	4 A

# FLOORWASH

## SPARE PARTS

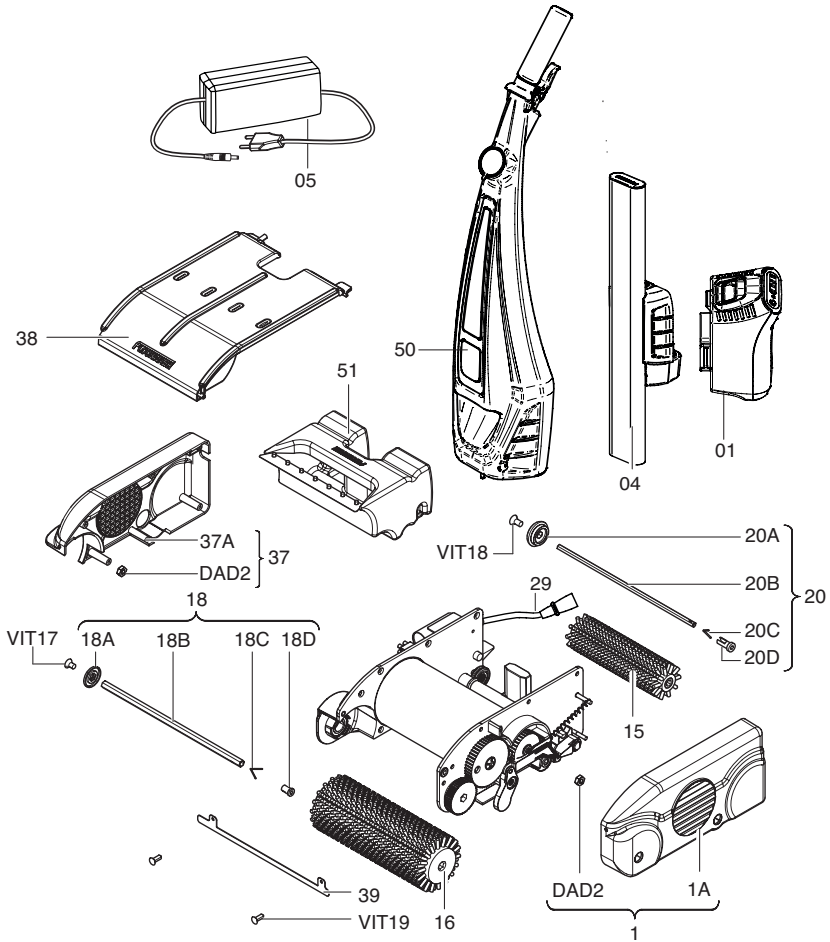

1	COMPLETE NYLON EXTERNAL LEFT SIDE
1A	NYLON EXTERNAL LEFT SIDE
DAD2	LOW SQUARE NUT 4MA
CAFB25	MACHINE BODY FB25
15	UNIVERSAL REAR BRUSH
16	UNIVERSAL FRONT BRUSH
18	COMPLETE HEXAGON SPRING PLUNGER CH10
18A	HEXAGON PLUNGER INSERT BUTTON CH10
18B	HEXAGON PLUNGER CH10
18C	SPRING LATCH FOR EXAGON PLUNGER CH10
18D	HEXAGON PLUNGER EJECT BUTTON CH10
20	COMPLETE HEXAGON SPRING PLUNGER CH7

20A	HEXAGON PLUNGER INSERT BUTTON CH7
20B	HEXAGON PLUNGER CH7
20C	SPRING LATCH FOR HEXAGON PLUNGER CH7
20D	HEXAGON PLUNGER EJECT BUTTON CH7
37	COMPLETE NYLON EXTERNAL RIGHT SIDE
37A	NYLON EXTERNAL RIGHT SIDE
38	COMPLETE COVER FB25
50	COMPLETE TANK
51	WASTE WATER TANK
SPA.BAT.01	COMPLETE BATTERY
SPA.BAT.04	COMPLETE HANDLE
SPA.BAT.05	COMPLETE CHARGER

## PACKAGING SPECIFICATIONS AND DIMENSIONS

The FB25 machine is delivered in a protective packaging. Ensure that the packaging is fully intact and that there are no signs of tempering when the product is taken over. In case of damage, the customer shall notify our customer service immediately.

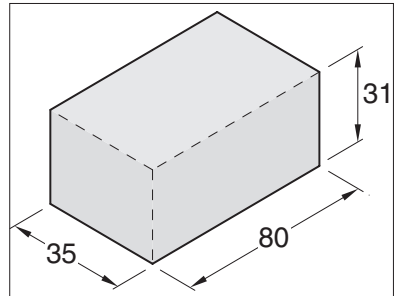

## MACHINE UNPACKING

### Follow the procedure below:

- 1 Place the packaging on the floor/work table softly by laying it down on the right part.
- 2 Open the external cardboard by using a pair of scissors, when necessary. (Do not use an utility knife).
- 3 Remove the machine body, tank and extensible tube, and place them on the floor softly.
- 4 Keep the cardboard box and its components away from sources of heat, in a dry and easily accessible place.



*Do not break or throw the packaging and its components away so that it can be used again for future transportation.*



*For your safety, wear protective gloves when carrying out these operations, in order to avoid injuries in case of accidental contact with sharp edges of the cardboard box, direct contact with detergent residues or metal edges.*

## MACHINE ASSEMBLY

Follow the procedure below:



The FB25 machine has a fast assembly system since no tools are required. Do not use any tool to avoid injuries or damage to the machine.

- 1** Place the body of the machine on a stable surface without slopes.

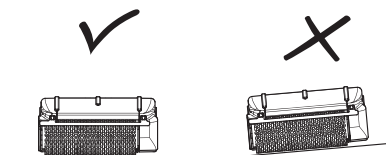

- 2** Insert the handle in the axle of the machine body.

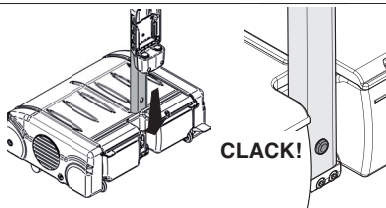

- 3** Insert the appropriate screw into the hole and, using a screwdriver, fix the handle to the machine body.

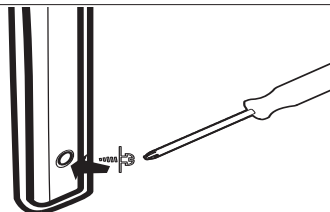

- 4** Insert the tank in the handle at the desired height (2 different heights).

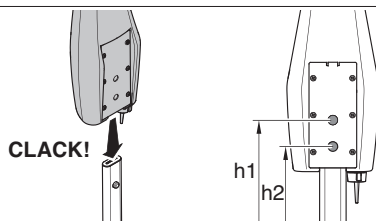

- 5** Insert the small transparent water tube in the relief valve situated on the lower part of the tank.

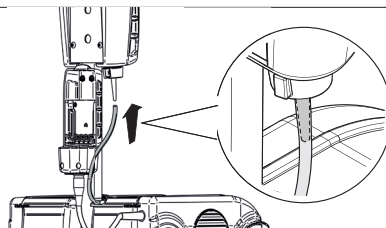

## INSTALLING THE BATTERY

Follow the procedure below:

 Make sure the battery is off before performing any operations

 Check the Battery charge level before use.

1 Insert the Battery into its holder.



2 Insert the plug into the socket located on the bottom of the battery holder.



## UNINSTALLING THE BATTERY

Follow the procedure below:

 Make sure the battery is off before performing any operations

1 Push the release lever upwards and, simultaneously, remove the plug from the socket located at the bottom of the battery holder.

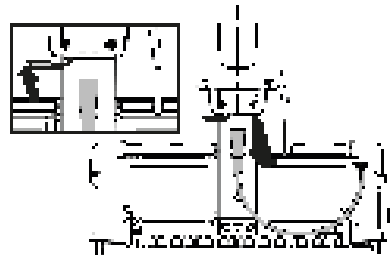

2 Gently push the battery down and at the same time pull the release button towards you.

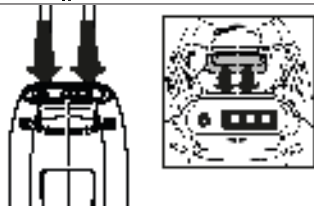

## CHARGING THE BATTERY

### Follow the procedure below:



*Make sure the battery is off before performing any operations*



*Use only the Charger supplied by the Manufacturer. Any damage or malfunction caused by the use of Chargers other than those supplied by the Manufacturer shall not be covered by the Warranty.*

- 1** Insert the plug of the power cable of the Charger into a 230 volt power outlet.

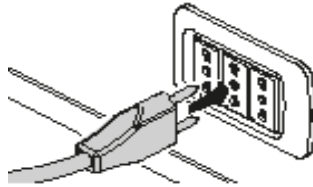

- 2** Plug the Charger connector into the socket located below the Battery.

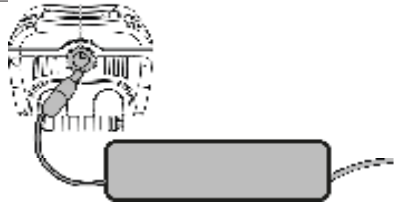

*The correct charging of the battery will be signaled by the intermittent lighting of one of the LEDs positioned on the membrane and by the lighting of the red light on the charger.*



*In case of overheating during the charging phase, the battery will automatically suspend the charge. Once the correct temperature has been restored, the Battery will automatically resume the charging phase.*



*When the battery is fully charged, the red light on the charger will turn green.*

## HOW TO GET STARTED



*The FB25 machine is a mechanical collection device that can achieve excellent results even with the use of water without detergent. An excellent result is achieved with the use of specific detergents.*



*The machine comes with universal brushes (gr 0.12). Anyway, it is possible to request specific brushes to our customer service according to the type of surface to be treated.*



*Use foam-controlled detergents to avoid excessive foaming. Do not use pure acids.*



*Wear protective gloves before handling detergents, alkaline or acid solutions to avoid hand injuries.*

**1** Remove the tank cap.

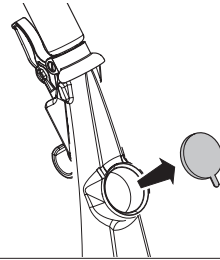

**2** Pour the liquid, clean water and/or detergent in the concentration specified on the label.

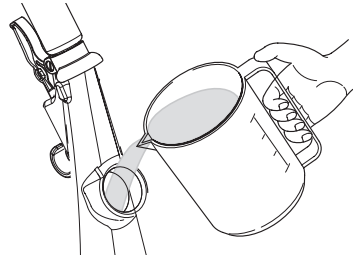

**3** Replace the tank cap.

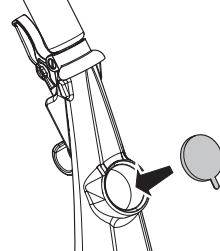

*Fill the tank with clean water and/or detergent for a maximum of 2lt. Use water at a temperature not exceeding 40°C or below 10°C.(104°F – 50°F).*



# FLOORWASH

## ON/OFF



*Make sure the battery is off before performing any operations*



*Before the start-up of the device, check that the electrical cord and the machine are not malfunctioning in any way. If this is not the case, do not use the device and contact our service centre as soon as possible.*

- 1** Press the power button located on the left side of the battery. Pay attention to the Caution led light indicating the correct ignition of the battery.

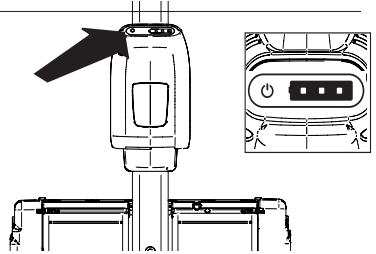

- 2** Press the kick-start pedal situated at the bottom-right side of the machine.

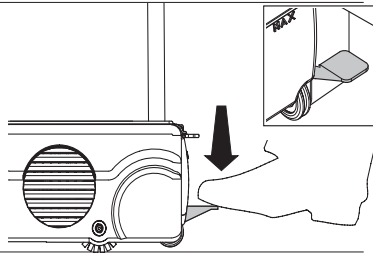

*It is important to press the kick - start pedal completely before lowering the tank towards you, so as to avoid any damage to the central axle of the machine body.*

- 3** While pressing the kick-start pedal, lower the tank towards you slowly. At this point, the machine will switch on automatically and brushes will start rotating.

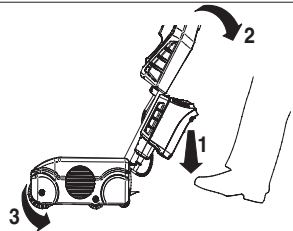

- 4** Be careful not to lower the handle excessively. Maintain a sufficient distance from the floor so that the battery does not touch the floor.

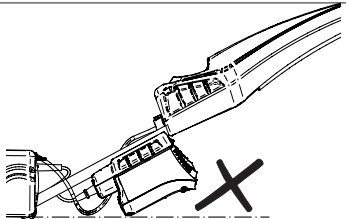

*Do not press the kick - start pedal when returning the tank to the original position.*

# FLOORWASH



Before starting the shutdown procedure, continue to use the appliance for at least ten seconds without dispensing water in order to complete the drying operation.

**5** The machine will switch off automatically when returning the tank to a vertical position (rest position).

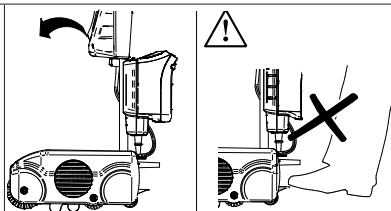

**6** Press the on / off button placed on the battery for 3 seconds to turn off the battery.

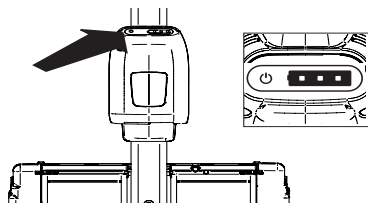

## BATTERY CHARGE LEVEL

The battery charge level is indicated by the appropriate led lights on the top of the battery. Depending on the number and colour of the led lights, the battery charge level can be

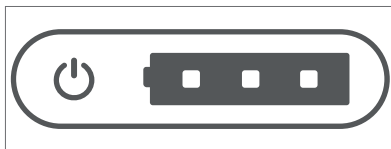

Led colour	Number	Battery level
Green	3	67%-100%
Green	2	34%-66%
Green	1	0%-33%



The battery will automatically shut off after 20 minutes of inactivity.

## FUNCTIONING

Check that all steps described above have been completed correctly before using the machine



*Before starting the washing procedure with the machine, remove any solid residual such as dust lumps, stones, glass, paper etc. from the surface which has to be treated.*

- 1 After the engine has turned on, move the machine back and forth with linear movements. The lever placed beneath the handle will allow you to dispense the liquid previously poured in the tank.

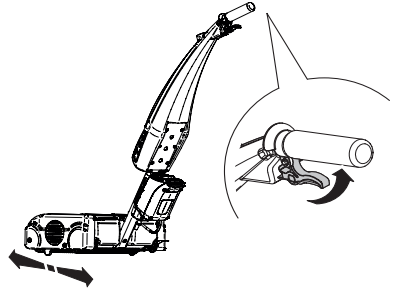

*The engine of this appliance is equipped with a safety device which cuts it off in case of overload. If this situation occurs, it is necessary to return the handle to its initial position, turn off the battery and turn it on again, and then resume normal work. In the event that the engine does not work again, contact our after-sales service.*



*Do not make circular movements with the machine so that it can collect the dispensed liquid.*

- 2 After pulling the lever, the liquid will distribute uniformly on the front cylinder brush.

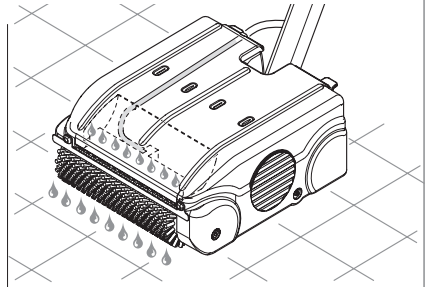

*In the ongoing stage just pull the lever halfway; in the retuning stage, release the lever, thus allowing the liquid recovery.*



*In the returning stage, the machine shall pass through the same hallway of the ongoing stage, thus allowing a complete recovery of the dispensed liquid.*

# FLOORWASH

- 3** The recovery of the dispensed liquid occurs automatically by means of mechanical collection. The liquid will flow into the waste situated in the lower part of the machine.

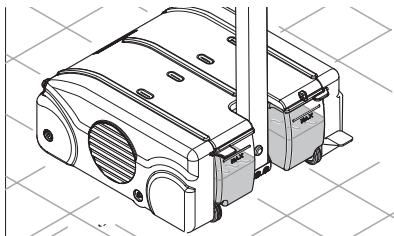

*It is important to empty the waste when the seep liquid reaches the maximum mark printed on the back of the waste, thus avoiding an accidental release of the same.*

## TRANSPORT

To transport the machine safely, follow these steps:



*Check that the tank is placed in a vertical position before moving the machine. The electrical cord shall be unplugged from the outlet.*

- 1** The machine has two rubber wheels situated in the lower part. By pulling the tank towards you, without pressing the kick - start pedal, the front part of the machine will be lifted up, guaranteeing an easy transportation..

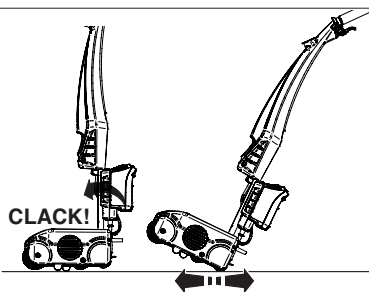

*If the liquid in the waste has reached the highest level, it is necessary to empty it before carrying the machine.*

- 2** It is possible to lift the entire machine up, in order to move it to an upper floor of the house, by using the designated slit situated on the lower part of the tank.



*Do not lift the machine up by using the upper knob of the tank.*



*For transportation with vehicles, ensure the machine so that it cannot in any way move.*

## AFTER CLEANING

After cleaning, follow these steps:

 Before carrying out any operation, check that the electrical cord is unplugged from the outlet.

 Wear protective gloves when carrying out these operations, in order to avoid direct contact with detergent residues or metal edges.

- 1** Open the upper cover of the machine by pushing the two lateral hooks up.

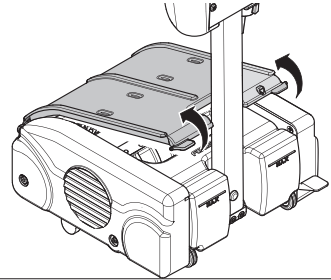

- 2** Remove and empty the dirty water waste. Wash it with running water and, if necessary, use a spatula to remove any residual from the bottom.

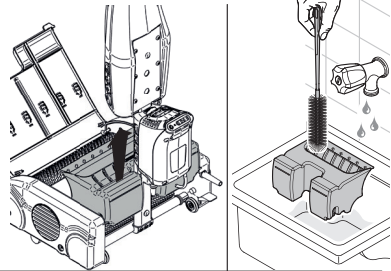

 The stainless-steel sheet welded to the waste is not removable. Do not try to remove it.

- 3** Unhook the upper cover and wash it gently with running water. Check that the drip tray and the water tube are not clogged.

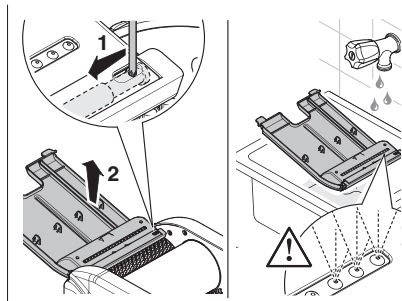

- 4** Unhook and drain the clean water tank 2 from any residual of water and/or detergent.

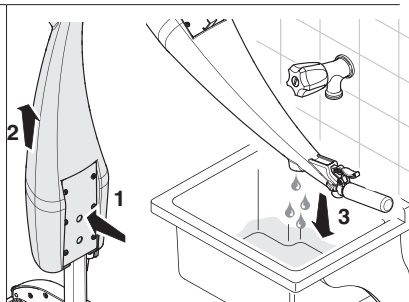

## MAINTENANCE

A regular maintenance keeps the machine safe and always ready to use. Carry out the following operations:



*Wear protective gloves when carrying out these operations, in order to avoid direct contact with metal edges or sharp plastic parts.*



*Before carrying out any maintenance work, remove the battery following the procedure indicated above.*

- 1** Unhook the handle from the machine body and place it on a work table.

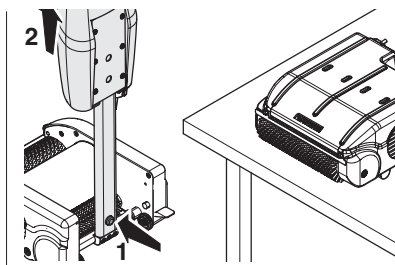

- 2** Unhook the upper cover of the machine and wash it thoroughly with running water.

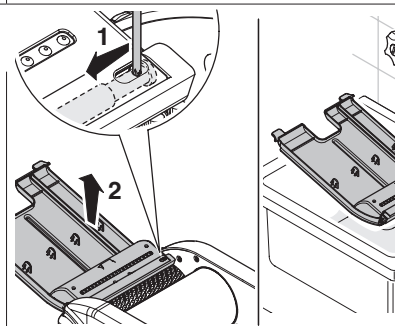

# FLOORWASH

- 3** Remove the brushes by pressing the button placed on the left side of the machine. Use a damp cloth to clean the internal sides of the machine while checking that seals are not clogged.

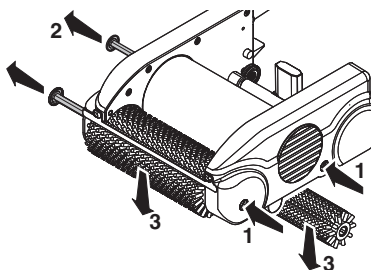

*In case of prolonged inactivity, carry out at least 1 battery recharge cycle every 3 months.*



*If not used for more than 3 months, make sure the battery is completely discharged and then carry out a complete recharge cycle.*

## TROUBLESHOOTING TIPS

The following are examples of some problems that may arise.



*If after completing the verifications listed below, you do not achieve positive outcomes, please contact our service support immediately.*

### **The fresh water tank loses**

Check that the water valve of the cable is fully screwed to the tank.

Check that the drive cable anchored to the lever of the liquid distribution is not too taut.

Check that the tank is fully intact and that there are no holes and/or cracks.

### **The machine does not distribute well the wash water**

Make sure that the drip tray placed under the cover is not clogged. Check that the transparent tube is not clogged or crimped.

### **The machine does not collect water**

Check that the waste is properly inserted and that the cover is completely closed and attached to the body. Check that the wash water drops on a regular basis when you pull the lever. Check that the brushes are not too worn.

**Floorwash® S.r.l.**

Via Camillo Golgi, 15 - 25036 Palazzolo sull'Oglio (BS) Italy

tel +39 030. 3372724

[customerservice@floorwash.com](mailto:customerservice@floorwash.com)